



SERC DOCTORAL STUDENT FORUM 2024 | NOVEMBER 13, 2024

# Exposing Bad Behavior in Operational Systems: An Unmanned Mission Model

Mr. John Philips



NAVAL  
POSTGRADUATE  
SCHOOL



# Outline

---

Bottom Line Up Front

---

Operational Situation

---

Motivation

---

Visual Model

---

Operational Context

---

Mission Modeling

---

Outcome Analysis

---

Requirements

---

Cost Analysis

---

Summary

---

# Bottom Line Up Front (BLUF)

---

- Issues

- A hybrid naval fleet of manned and unmanned platforms have a high risk of undocumented or poorly understood requirements.
- While policy directs a transition to digital engineering (DE) techniques, there is little evidence that demonstrates the benefits of model-based systems engineering (MBSE).

- So What?

- Developed and refined a method to model system and system-of-systems (SoS) behavior
- Demonstrated using models and analysis alone to reveal a latent issue in an operational system-of-systems
  - Would have remained unfound with only system modeling.

“MBSE promises increased quality and affordability for one simple reason: The cheapest defect to fix is the one you prevented.”





# Operational Scenario

- A Country X survey ship, SEARCHER (AGOR-01), has been spotted in the vicinity of an underwater optical data cable.
  - Carries worldwide data including information between the United States and allied partners.
- USS DEEP WATER (SS-14) with elements of UUV Team 3 is tasked with conducting a search mission over the position and monitoring the movements of AGOR-01.
- While in transit, AGOR-01 gets underway. SS-14 launches two UUVs then continues on an intercept course.
  - The UUVs autonomously complete the search mission and are then recovered by the USS SHALLOW WATER (SC-22).



# Questions

- If one or both UUVs fails to return to the Recovery Point, can we use models to:
  - Understand what went wrong?
  - Characterize mitigations to increase the likelihood of success?
  - Appreciate the implications of a change to the system prior to development?



# Build a Visual Model

First, we transition from a mental model of the operational scenario to a more formal model of the problem space.

1. Two UUVs are launched from USS DEEP WATER (SS-14).
2. The UUVs complete an ingress along the path of the cable leading to the search area.
3. Each UUV completes a Survey Task over the assigned portion of the Search Area.
4. Each UUV meets at a Rendezvous position to exchange information then continues to localize any detected targets of interest.
5. Once complete, each UUV transits away from the cable towards the vicinity of USS SHALLOW WATER (SC-22)
6. The UUVs are recovered by SC-22.

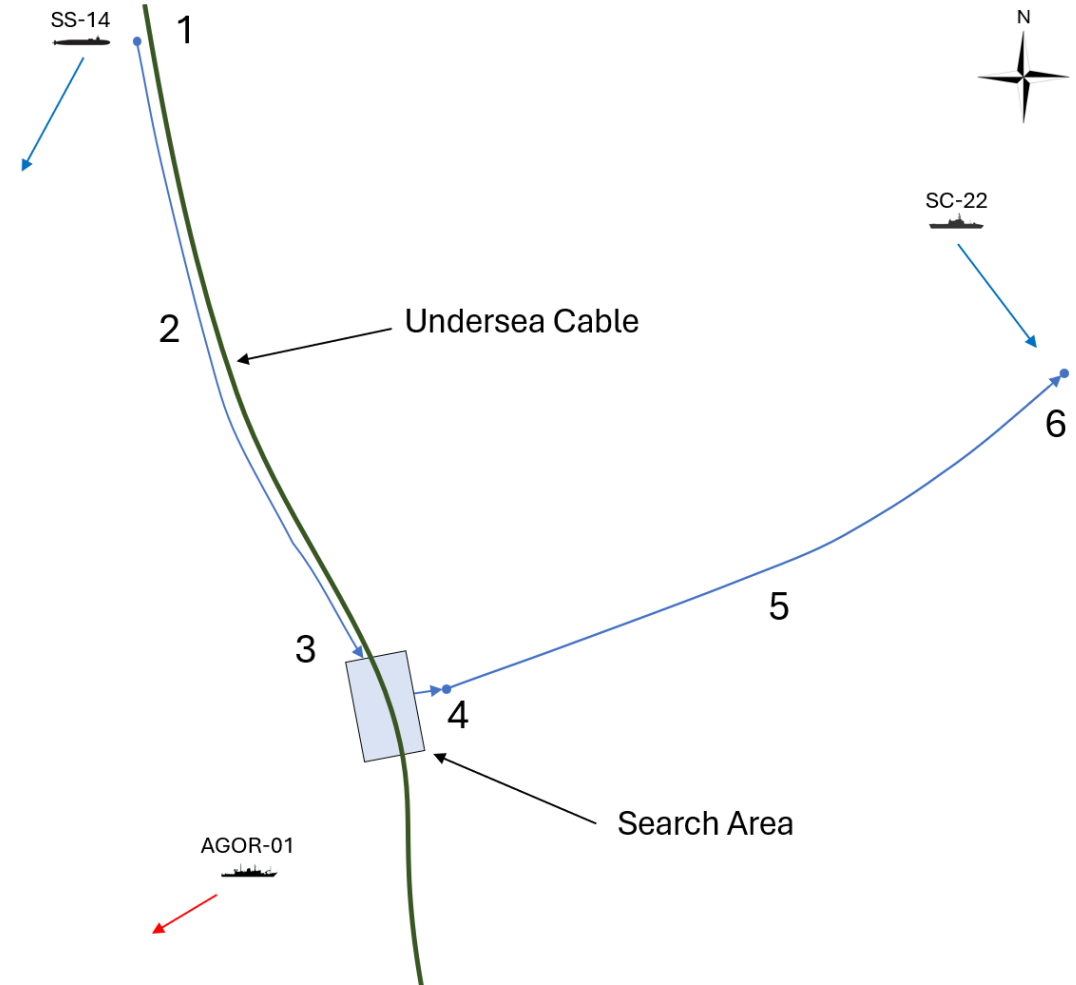

# Understand the Operational Context

Next, we identify the key actors and actions.

- UUV System (SOI)
  - Two UUVs that conduct the search mission
- External actors involved in the search mission
  - Task Unit Commander
    - Tasks the UUV System and receives results of mission
  - Vessel of Opportunity (VOO)
    - Supports launch and recovery of the UUVs
  - Environment
    - Search areas containing targets of interest
    - Position information

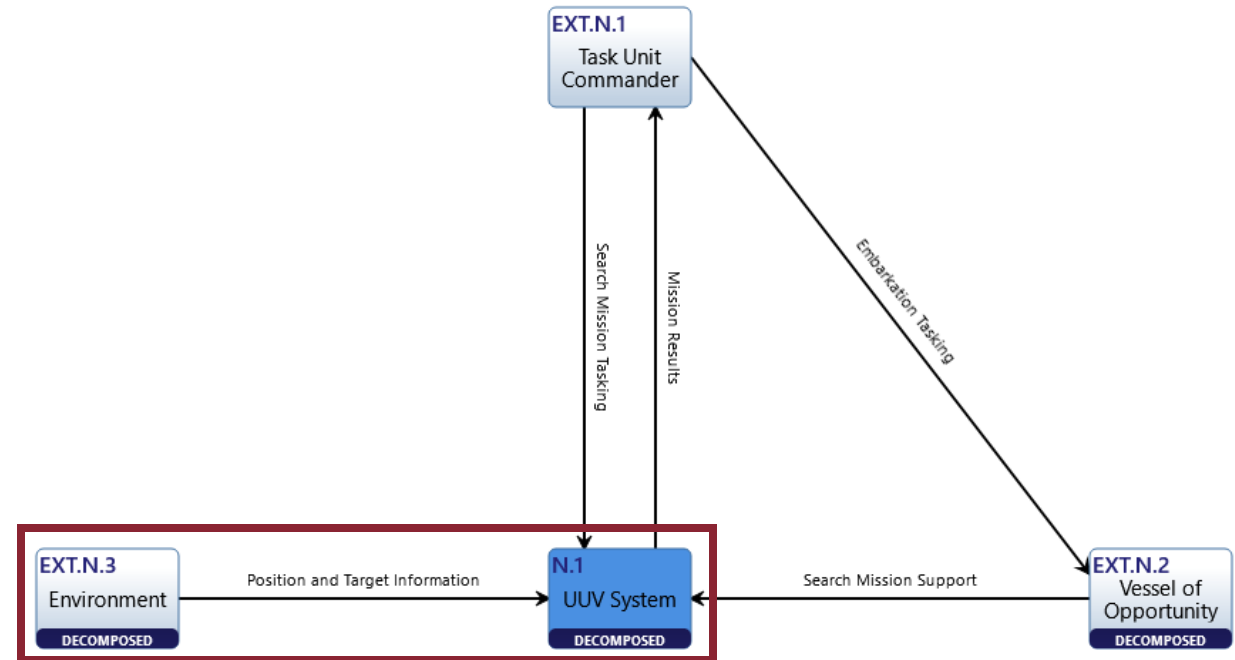

Modeling is focused on the interactions between the two in-mission UUVs and the Environment.

# A UUV Mission Model

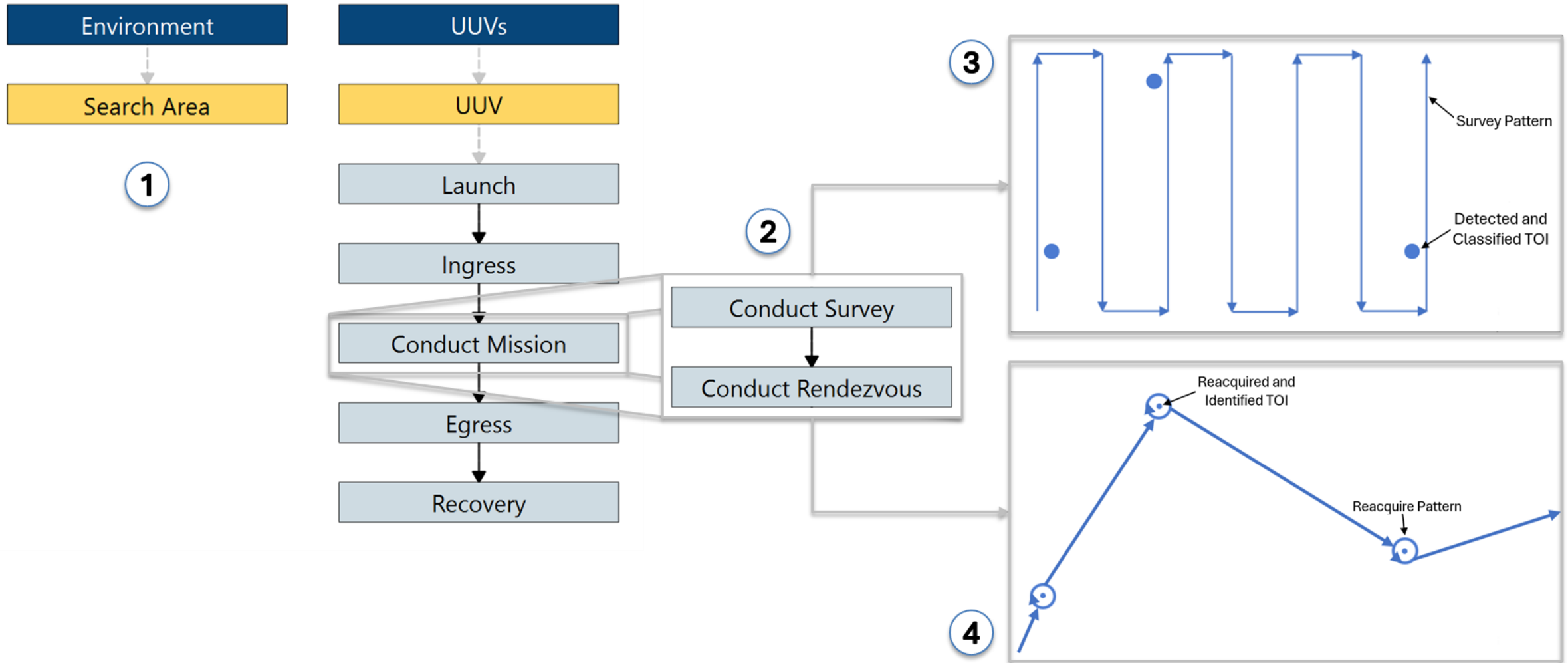



# Mission Outcomes

- 4617 total outcomes for the search mission after analysis and pruning
  - Logical – removes outcomes that “break” logic
  - Simplification – removes outcomes to focus the analysis.
  - Scope – removes outcomes from outside the context

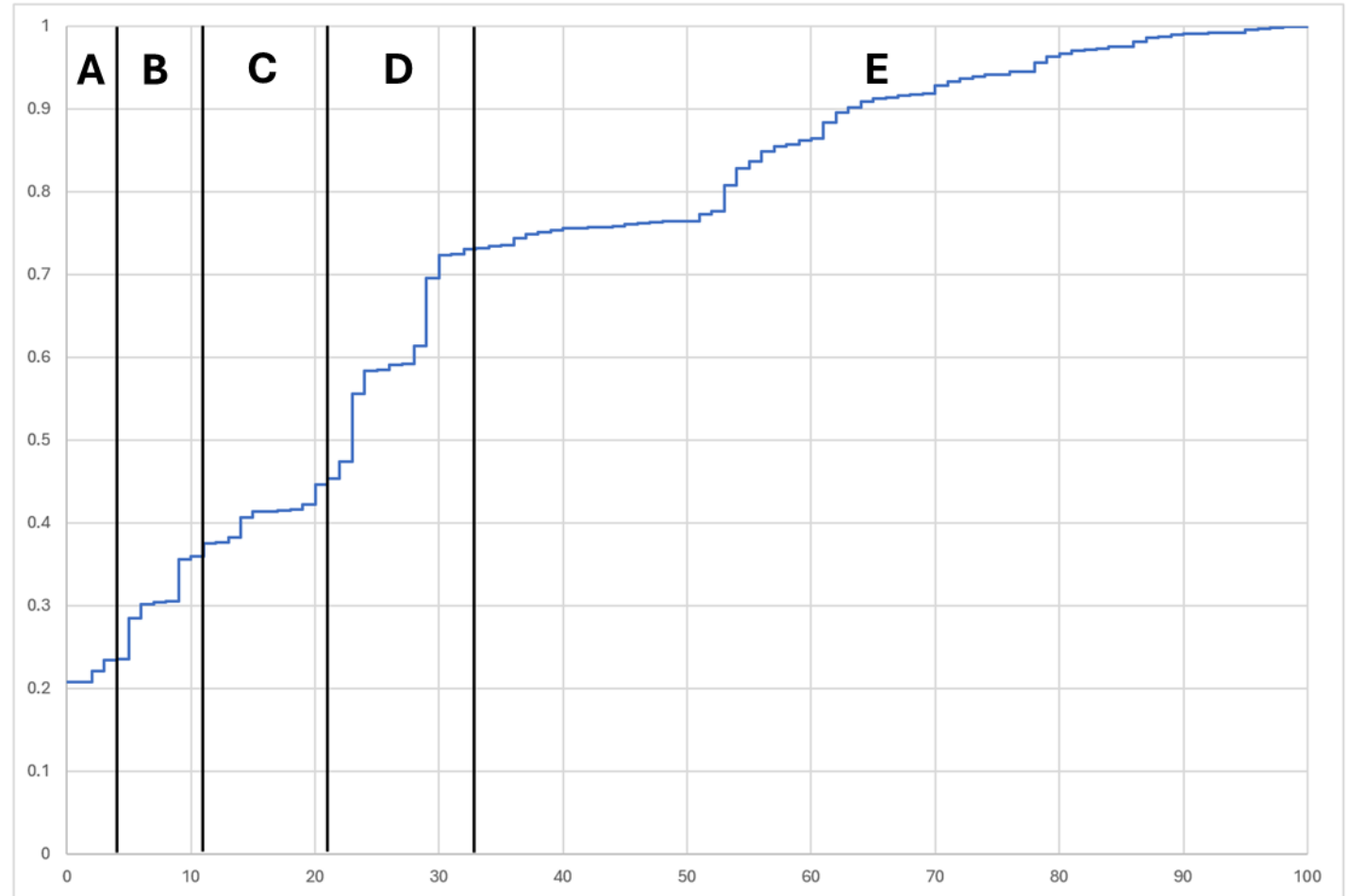

# Analysis – Mission Failure

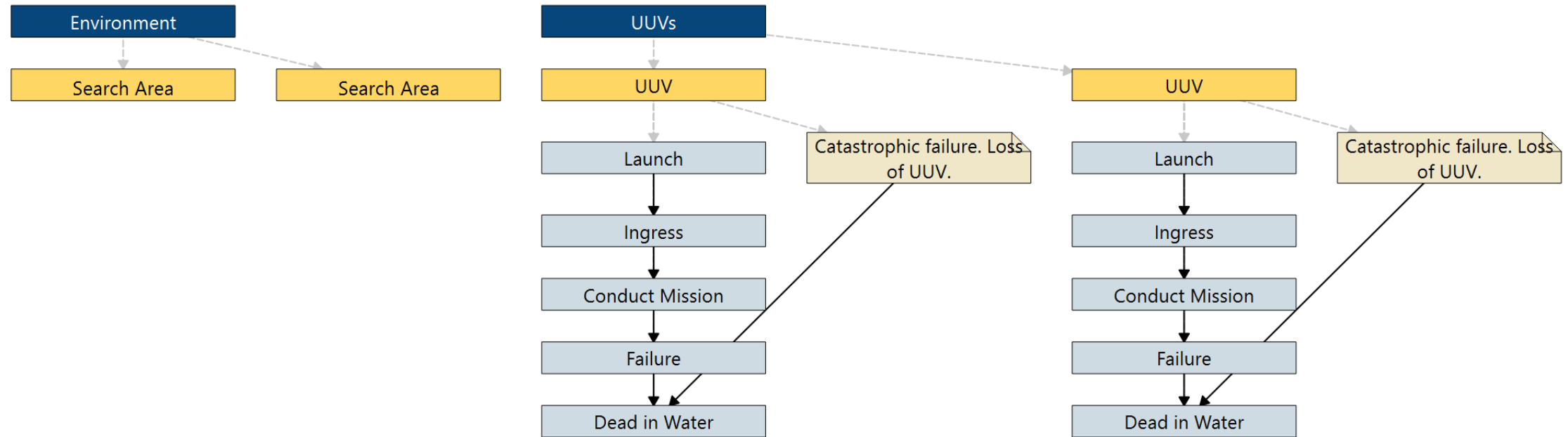

- Both UUVs experience a catastrophic failure during the mission.
- What could cause this outcome?
- Zoom into the individual task models.

# Analysis – Survey Task Failure

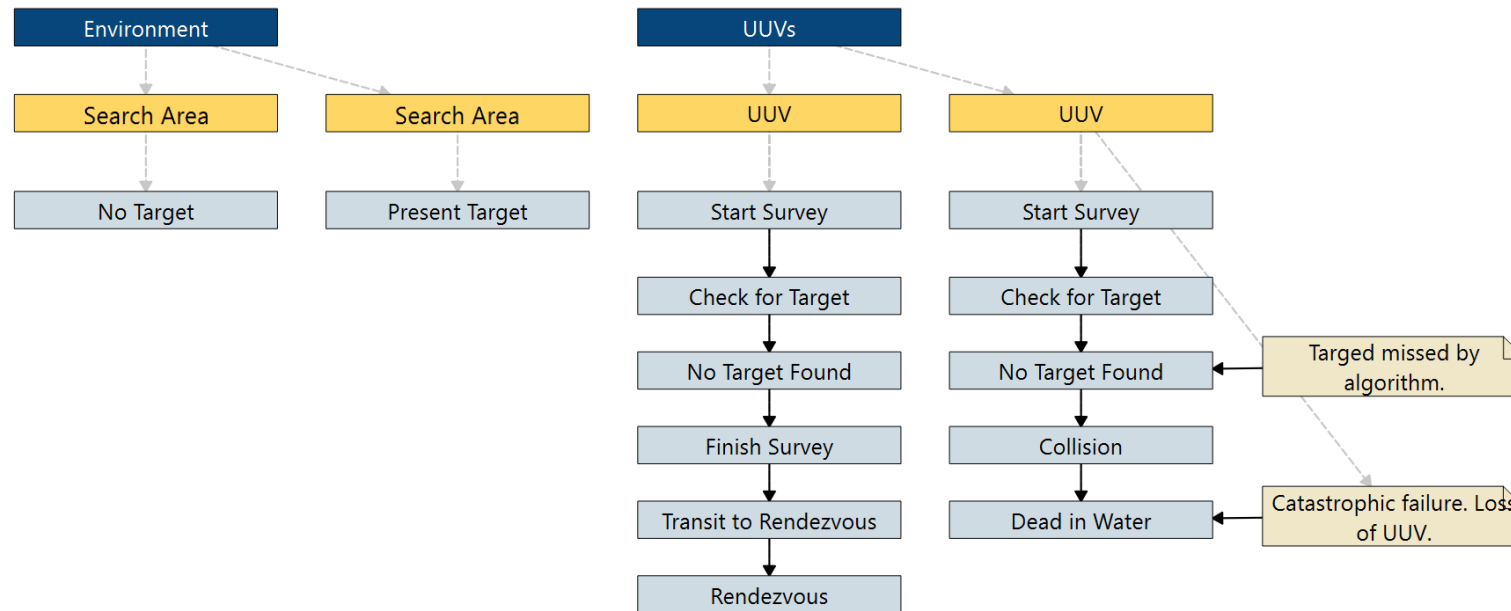

- UUV 1 operates as expected.
- UUV 2 fails to detect a target in the Search Area and Collides.

# Analysis – Survey Task

1. UUV 1 starts the Survey Task in the first Search Area moving south.
2. UUV 2 continues south and starts in the second Search Area moving north.
3. UUV 1 collides with an unknown target in its flight path, rendering it dead in the water.
4. UUV 2 completes the Survey Task and continues to the Rendezvous position.

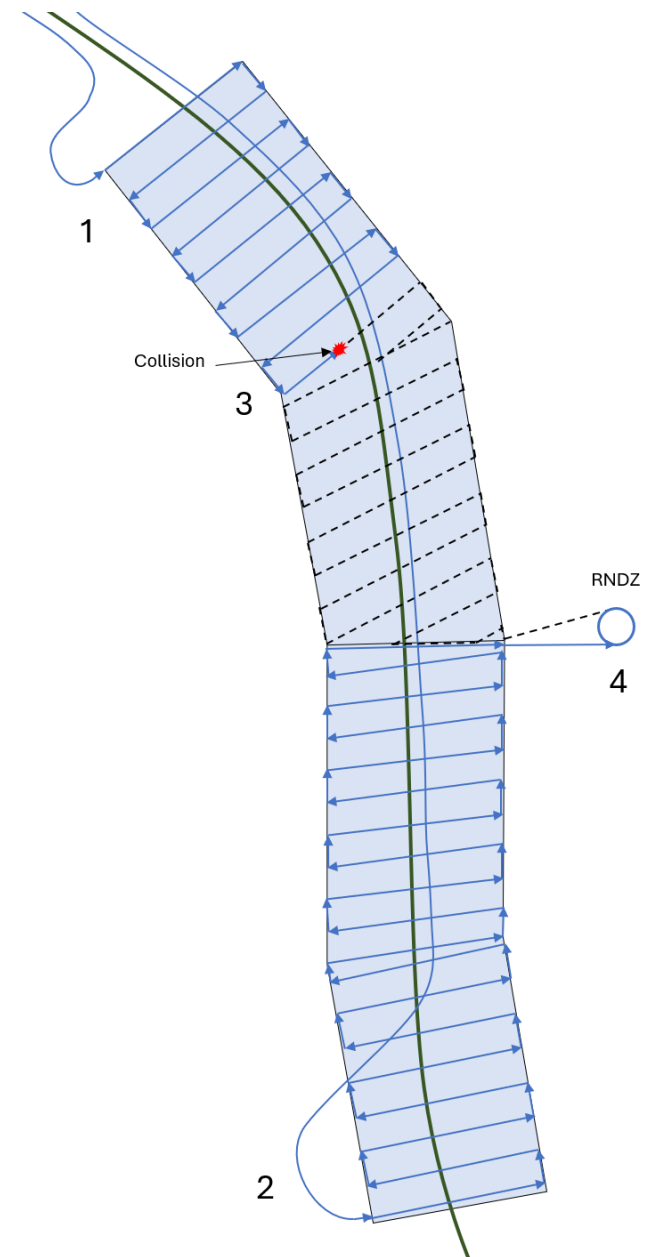

# Analysis – Rendezvous Task Failure

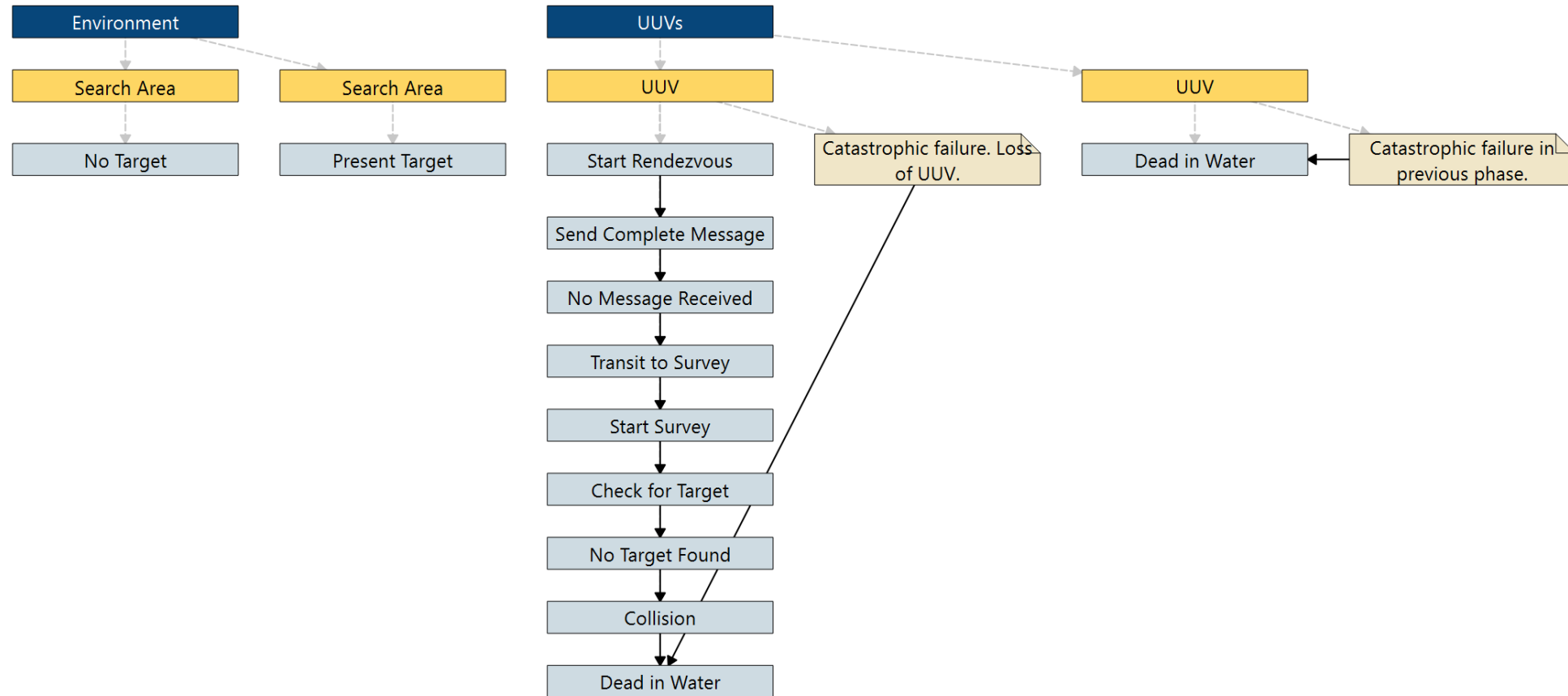

UUV 1 attempts to complete UUV 2s Survey Task and suffers the same fate.



# Analysis – Rendezvous Task

UUV 1 is dead in the water from colliding with an undetected target in the northern Search Area.

5. After not hearing from UUV 1, UUV 2 assumes the northern survey is incomplete.
6. Continues to the southern edge of the Search Area and moves north.
7. UUV 2 collides with the same unknown target, rendering it dead in the water.

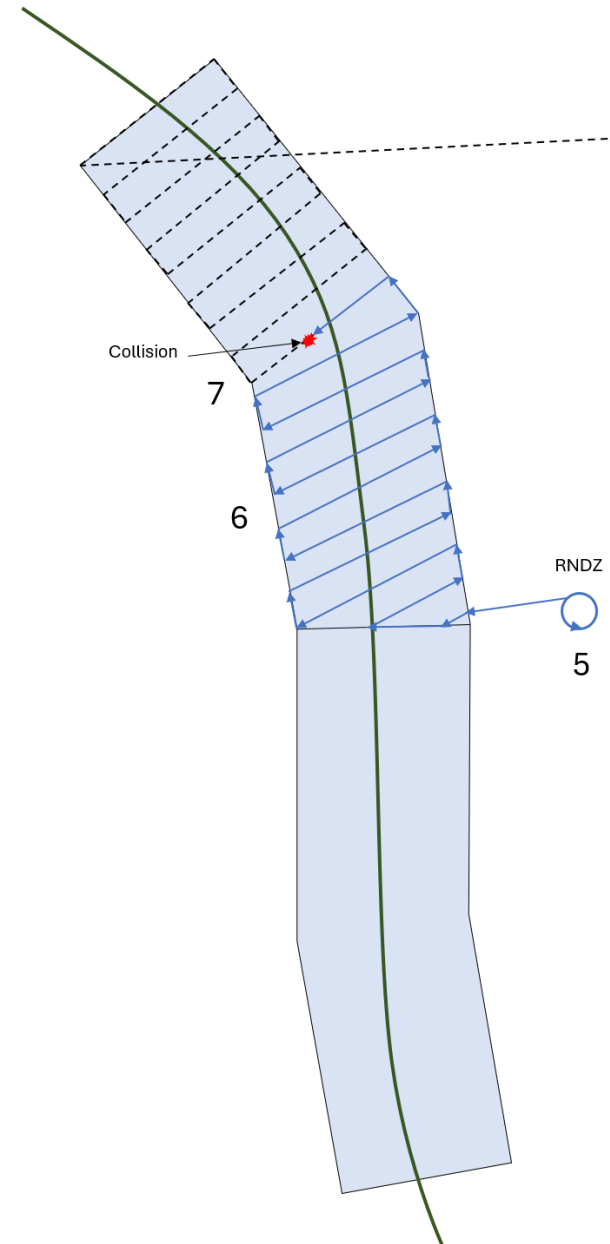

# What's Going On? – Changed Requirements

- A. UUV 2 completes the Survey Task, detects Targets of Interest, and transits at the newly implemented Rendezvous location (RNDZ) to exchange information with UUV 1.

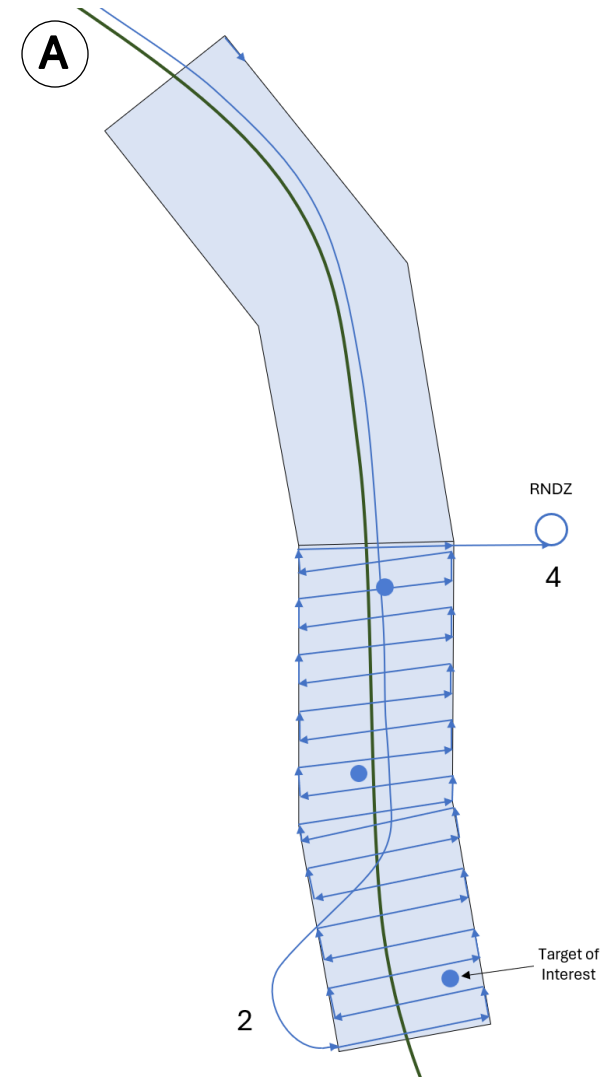

If UUV 2 never hears from UUV 1 what should happen next?

# Analysis – Requirements Derivation

**B.** Option to prioritize a complete survey of the Search Area

**C.** Option to prioritize identification of targets

Option B was selected by the program for implementation.

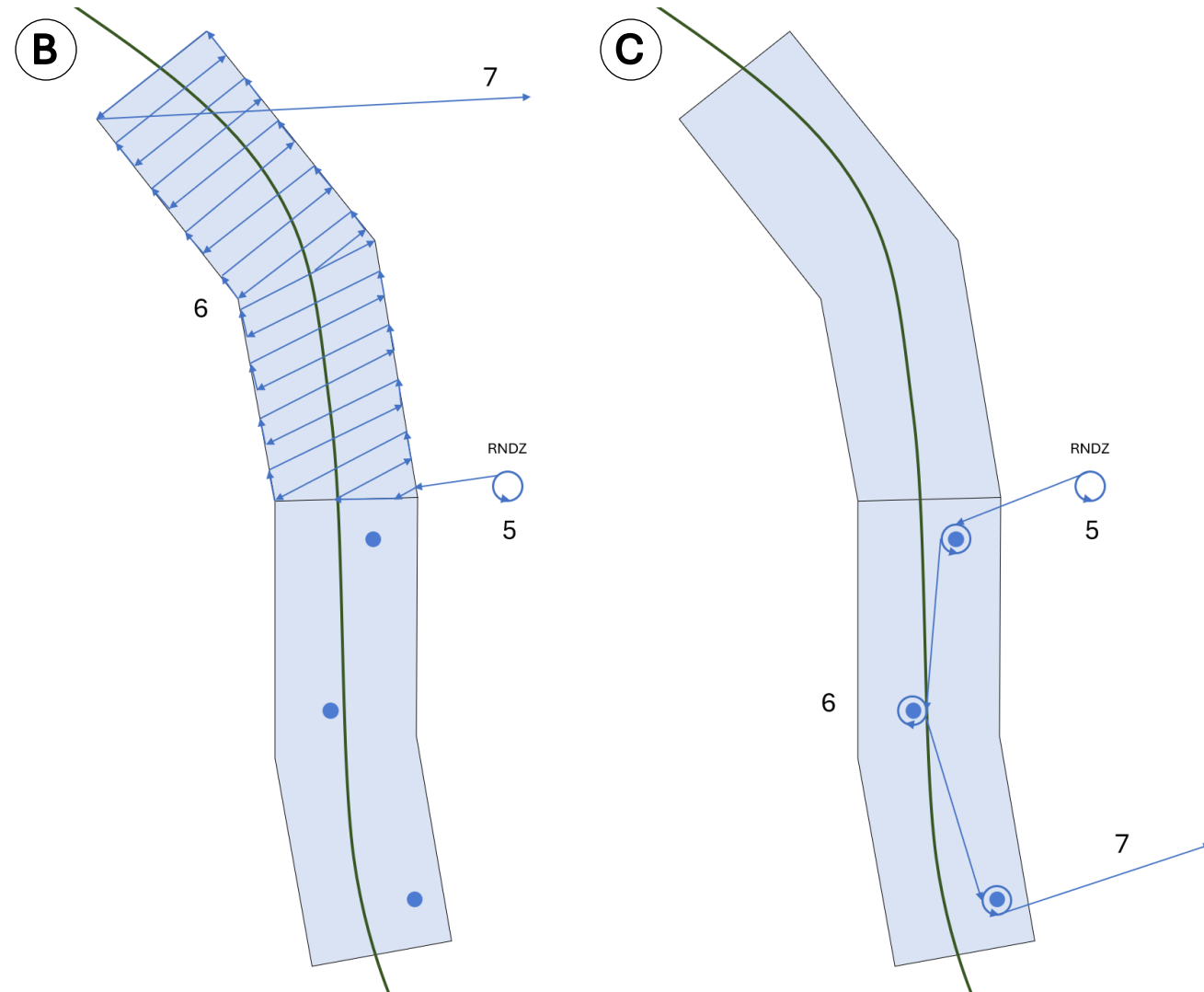



# What Does it Take?

---

- Develop and verify the **reusable** models
  - \$30K over four weeks
  - Two UUVs running 24 hour search mission
    - 0.7% chance of catastrophic collision
    - 50% chance that the track of the second UUV is close enough to collide with the same object
    - \$1.5M replacement cost
- Analyze the results and discover the issue
  - \$6K over one week between an SME and modeler



# Why Does it Matter?

---

- There is little scientific evidence that demonstrates the benefits of MBSE.
  - 360 of 847 papers in a literature review cited the “potential” of MBSE, only 2 provided a measured result
  - Data collection, analysis, and repeatable methods
- This work demonstrates the “how” of coupling SE with models, automated tools, and subject matter expertise to find issues.
  - Used systems modeling tools, visual models, and the formal methods to expose an issue that would have remained hidden if only the individual UUV was modeled.
  - In this case, use models to consider alternatives **before** development, e.g., offset the survey tracks to lower the chance of a second collision.





**SYSTEMS**  
**ENGINEERING**  
RESEARCH CENTER

# Thank you!

Stay connected with SERC Online:



Email the presenter: Mr. John Phillips

 [john.phillips1@nps.edu](mailto:john.phillips1@nps.edu)

# Unmanned Systems

- To meet strategic objectives, the Navy needs a new hybrid fleet of manned and unmanned systems (UxS).
  - Extend sensor reach, provide additional weapons capacity, and supplement logistics in a resource-constrained environment.
- New technologies show promise but introduce new risk not present with current systems
  - China, Russia, and Iran have captured, tampered with, or destroyed U.S. UxS



# Systems Modeling

- Systems are made to address a need, i.e., each system has a purpose.
- Models are abstractions of a system, aimed at answering a question of interest.
- System models describe what it needs to do (requirements, behavior, structure) and the analysis between each domain.
- Current languages, tools, and methods capture what we want but lack a clear way to understand what is possible.

“We do not think and talk about what we see; we see what we are able to think and talk about.”

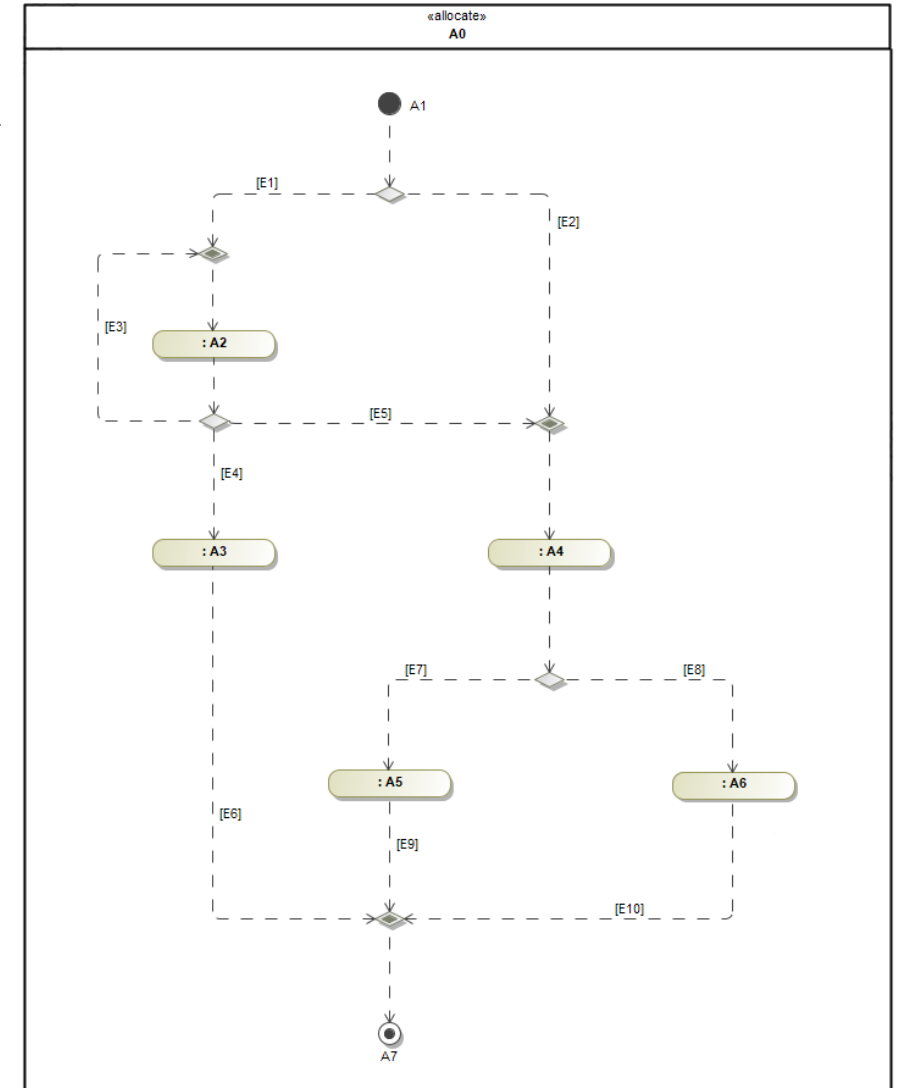



# Monterey Phoenix

- Monterey Phoenix (MP) is a formal language developed by the Naval Postgraduate School for behavior modeling.
- Used to help understand intended behavior, uncover assumptions, and expose emergent system or process behaviors.
  - What is the intended sequence of events?
  - What are the range of potential outcomes?
  - How many outcomes contain unexpected behaviors?
  - What risk do these behaviors pose to the system and/or process?
    - How can these risks be mitigated?

# Monterey Phoenix – How it Works

- Based on the stakeholder needs, model the initial problem space.
  - System of Interest (SOI), the external actors, and their individual behavior.
- Formally express the behavior in MP language, i.e., a directed graph.

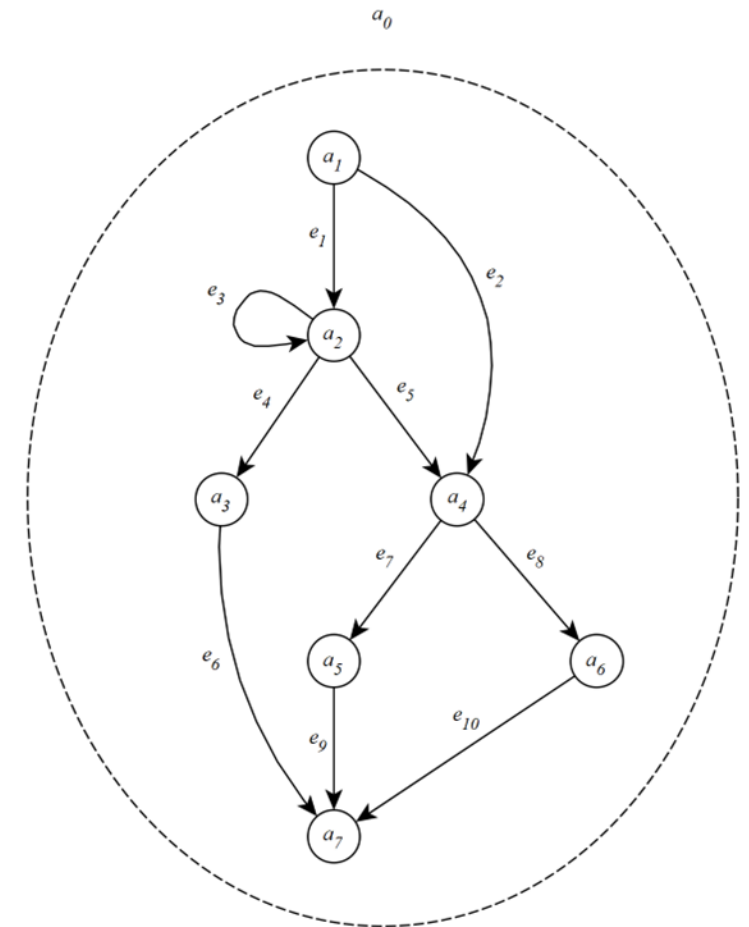
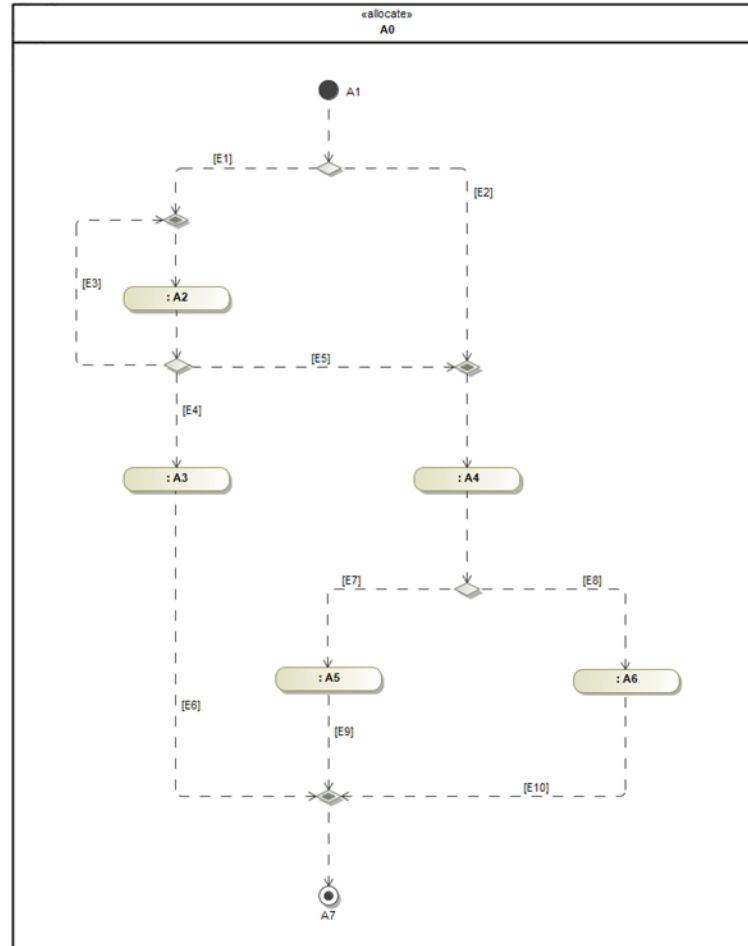



# Monterey Phoenix – Outcome Generation

- After you transition from SysML to the MP language. The corresponding tool rapidly generates all possible paths through a given graph.
- SOI  $a_0$ 
  - 7 nodes,  $a_1 - a_7$
  - 10 edges,  $e_1 - e_{10}$

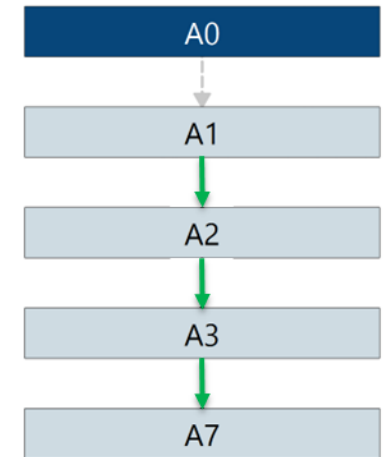
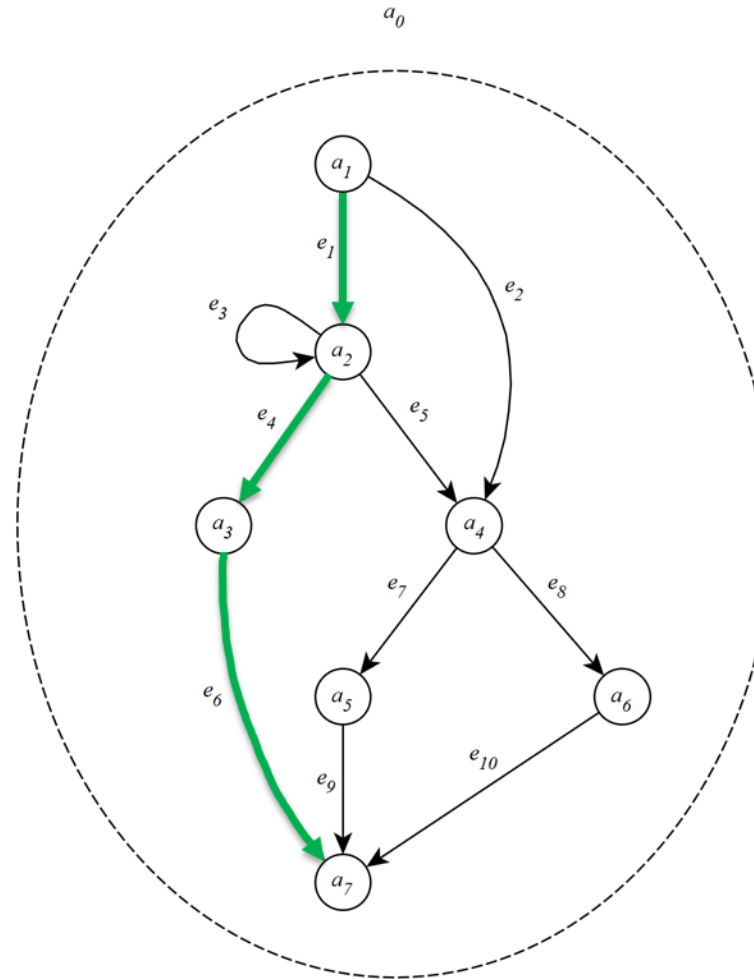

# Monterey Phoenix – Added Complexity

- Add an external actor, system  $b_0$
- Generate the outcomes of each actor and review to clarify
  - 5  $a_0$  and 3  $b_0$  outcomes
  - 15 outcomes
- Add cross-system interactions
  - 2 edges,  $x_1 - x_2$
  - 5 outcomes
- Powerful at high numbers to filter, reject, and rigorously expose and document what we want our systems to do, i.e., define the functional requirements, compared to what is possible.

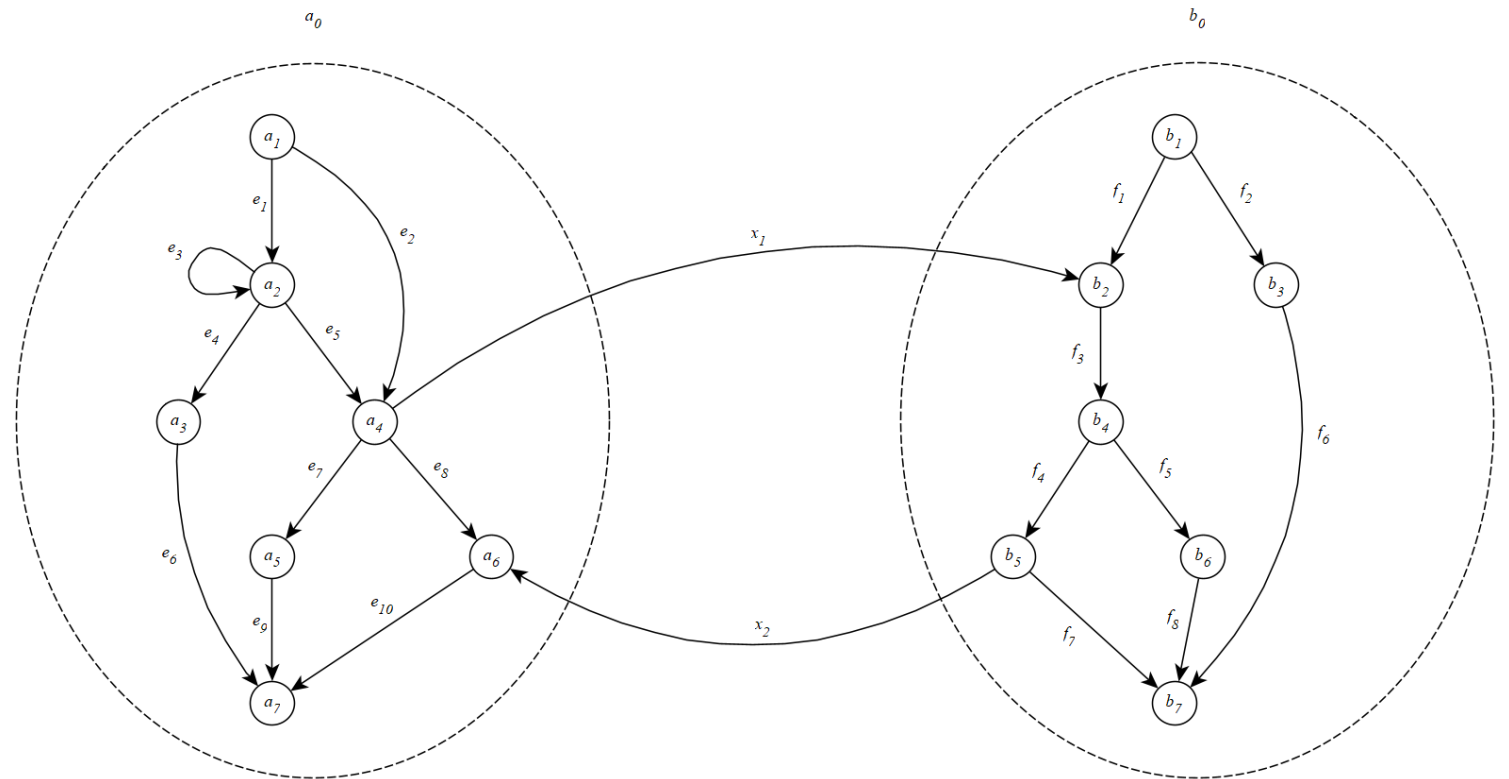

# Monterey Phoenix – Outcome Generation

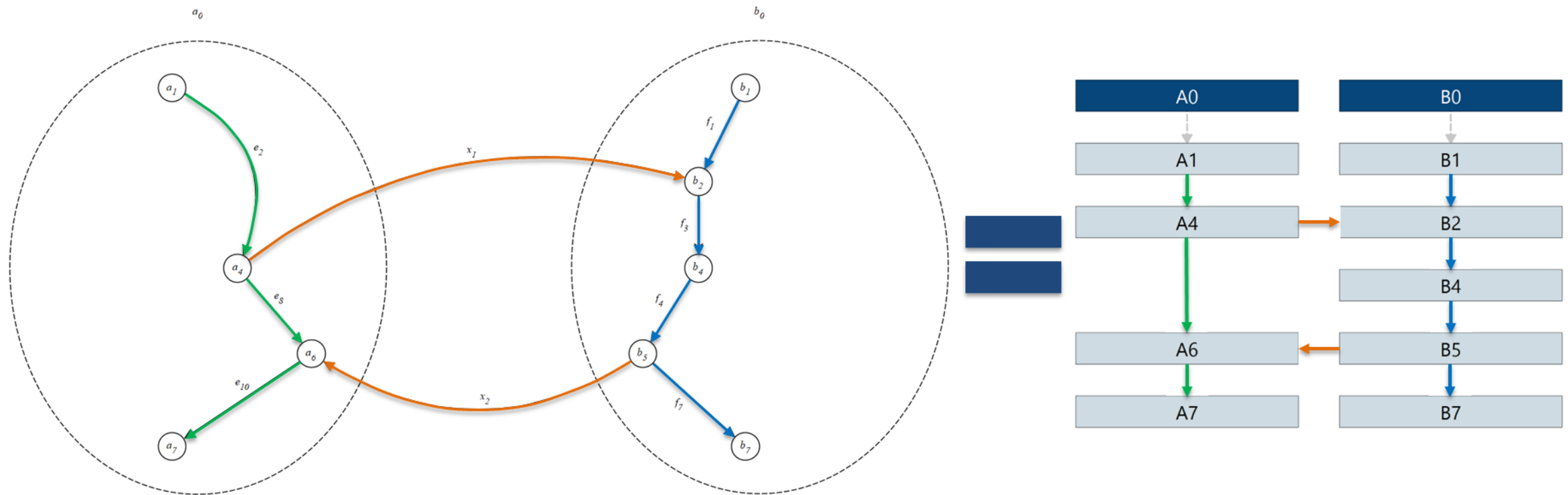

Quickly iterate between the planned architecture and what is possible to expose unexpected and unacceptable behavior.

# Operational Context - Design Reference Mission

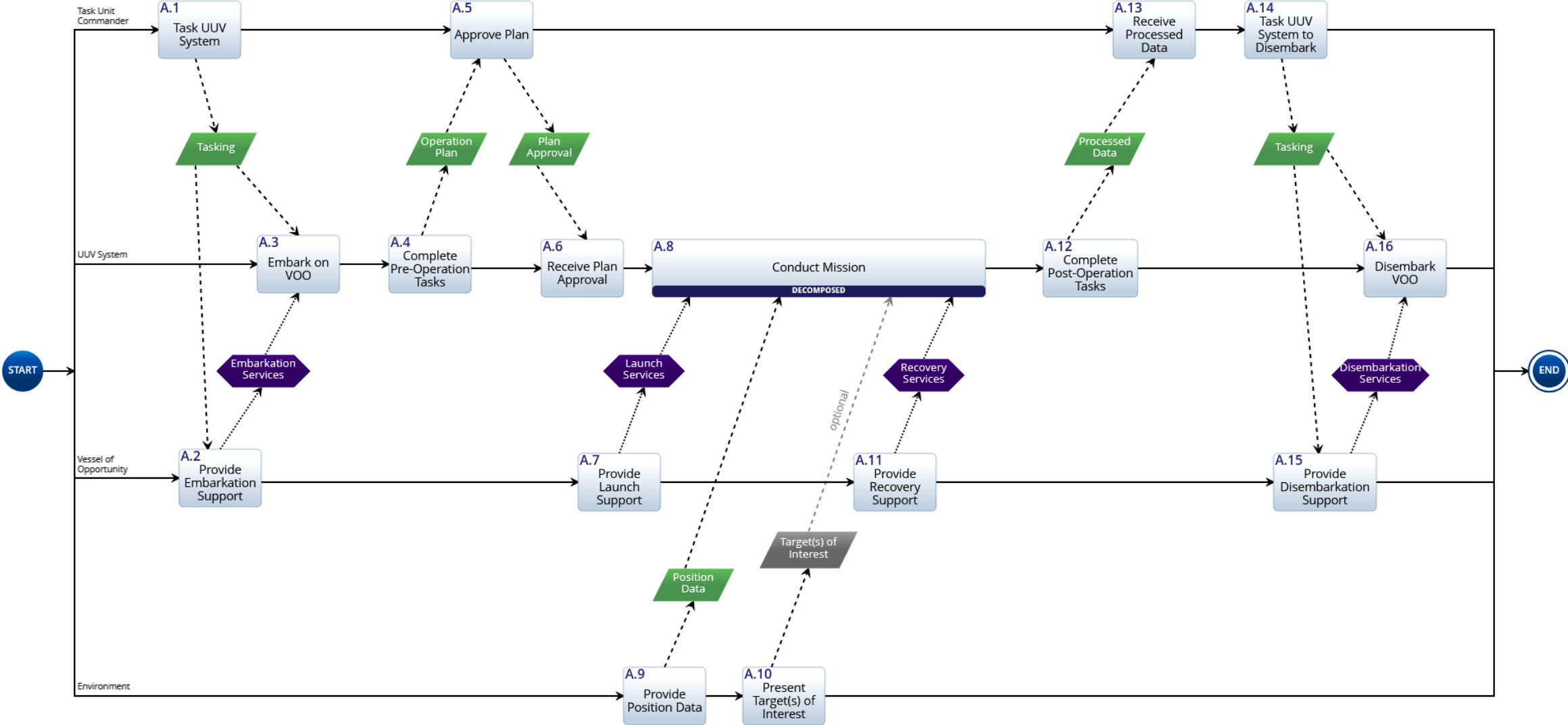

# Operational Context - Design Reference Mission

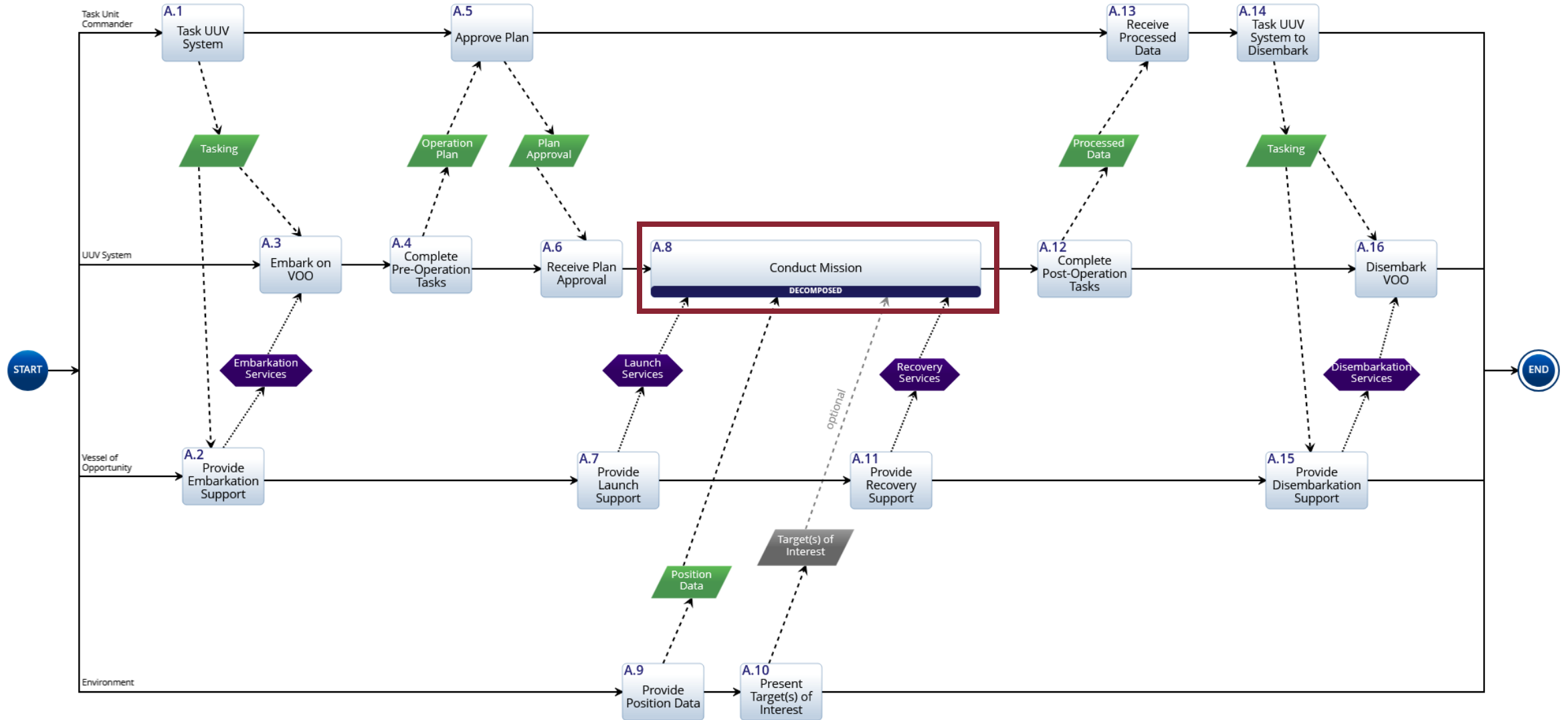

# Operational Context – UUV Mission

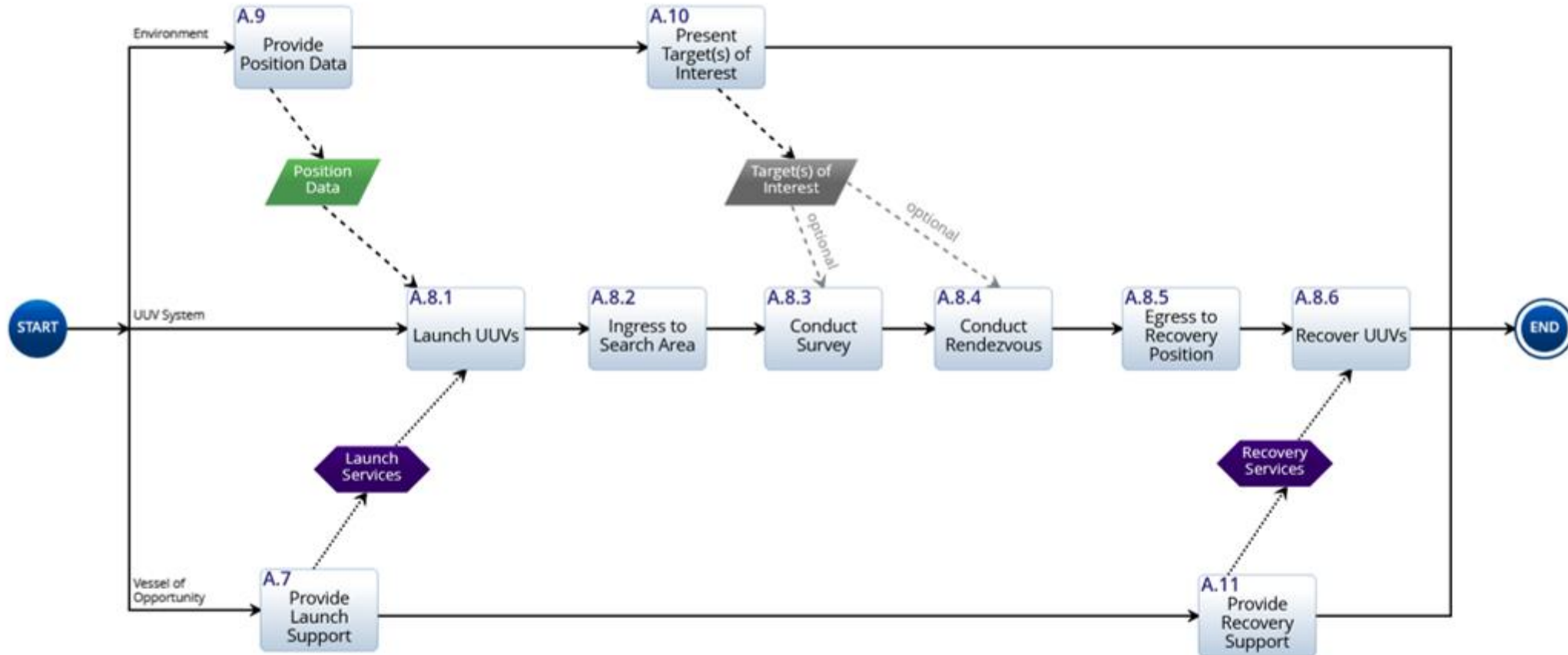

# Operational Context – UUV Mission

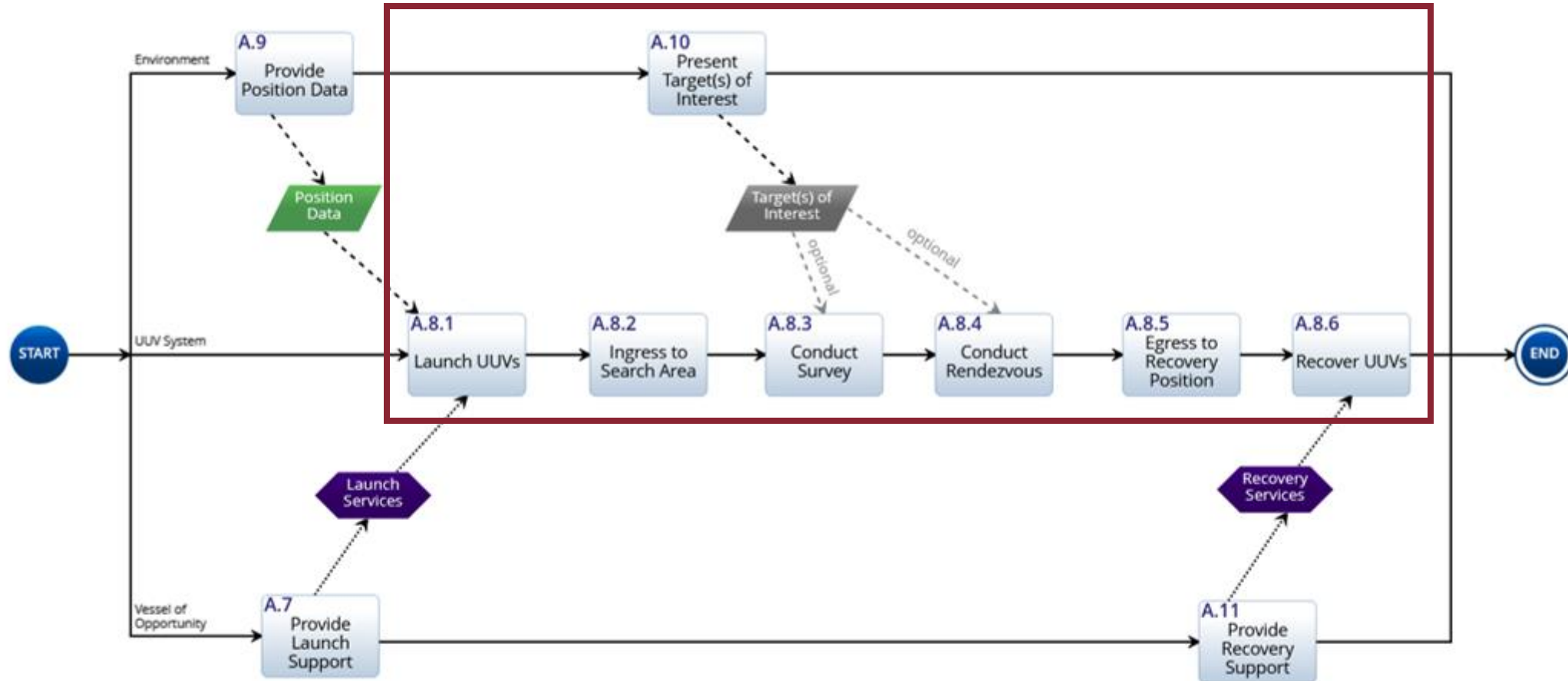



# UUV Mission – Success

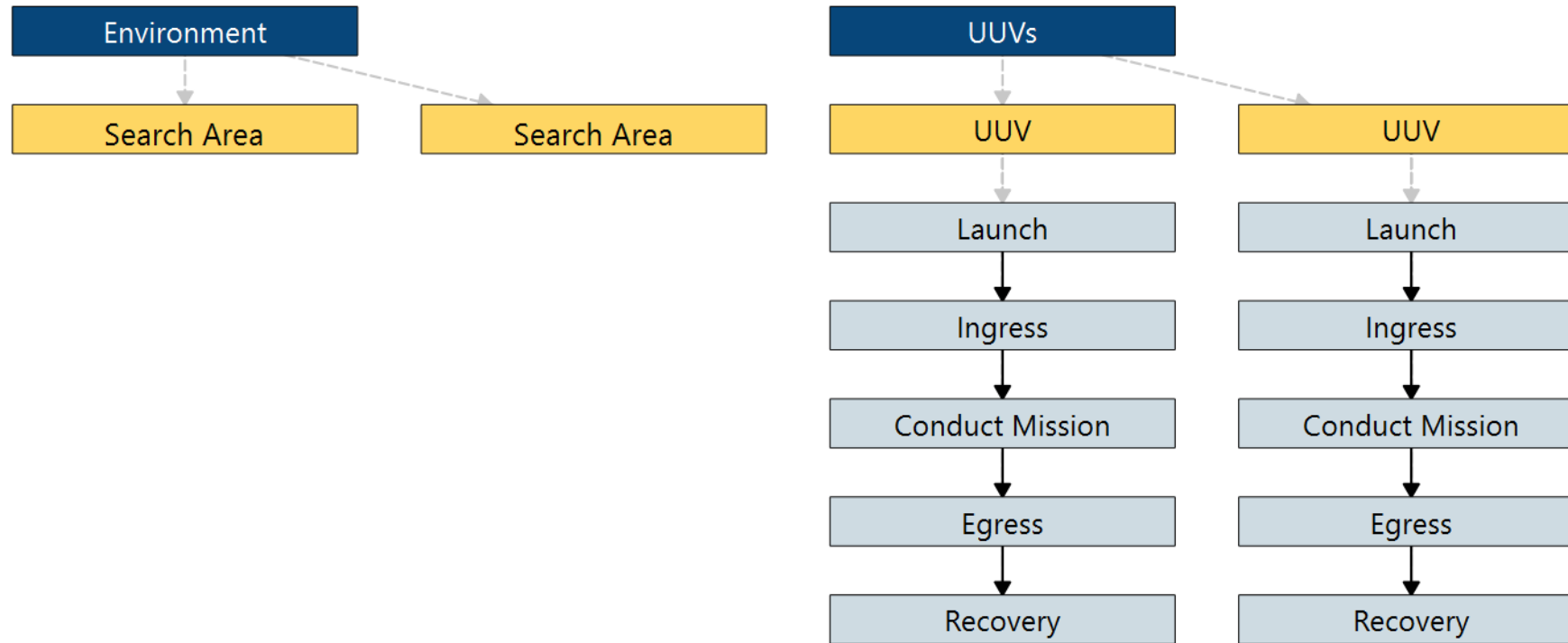

- Focused on a two UUV system conducting the mission.
- Quantitate analysis of failure rates and underwater communication